

# UPSTATE - ADMINISTRATION BUILDING

## GUTTER REPLACEMENT AND ROOF REPAIR

WMBE PROJECT NUMBER: 2019-131

PROJECT NUMBER:  
H34-954650002916-14

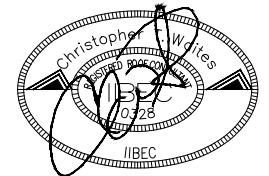

DESIGNED: CW

UPSTATE - ADMINISTRATION BUILDING  
GUTTER REPLACEMENT AND ROOF REPAIR  
PROJECT NUMBER H34-954650002916-14

800 UNIVERSITY WAY  
SPARTANBURG, SC 29303

### DRAWING LEGEND

### SITE LOCATIONS

### CODE/INDUSTRY STANDARD REFERENCES

2015 IBC  
2015 IEBC  
2009 IECC  
NRCA - LATEST EDITION  
SMACNA - LATEST EDITION

### WIND UPLIFT

FIELD 28 PSF  
PERIMETER 42 PSF  
CORNER 98 PSF

SEISMIC REQUIREMENTS - IEBC

### DRAWING SHEETS









R-1.0 COVER PAGE  
R-1.1 EXISTING ROOF PLAN  
R-1.2 ROOF REPAIR PLAN  
D-1.1 DETAILS

### ABBREVIATIONS

MIN MINIMUM  
MAX MAXIMUM  
NRCA NATIONAL ROOFING CONTRACTORS ASSOCIATION  
O.C. ON CENTER  
SMACNA SHEET METAL AND AIR CONDITIONING CONTRACTORS NATIONAL ASSOCIATION

### JOB CONTACTS

WMBE CHRIS WAITES  
803-260-4532  
CHRIS@WMBECONSULTANTS.COM

-  CHIMNEY
-  BELL TOWER
-  ROOF EDGE
-  ROOF RIDGE
-  ROOF VALLEY
-  GUTTER SYSTEM
-  DOWNSPOUT
-  GUTTER EXPANSION JOINT

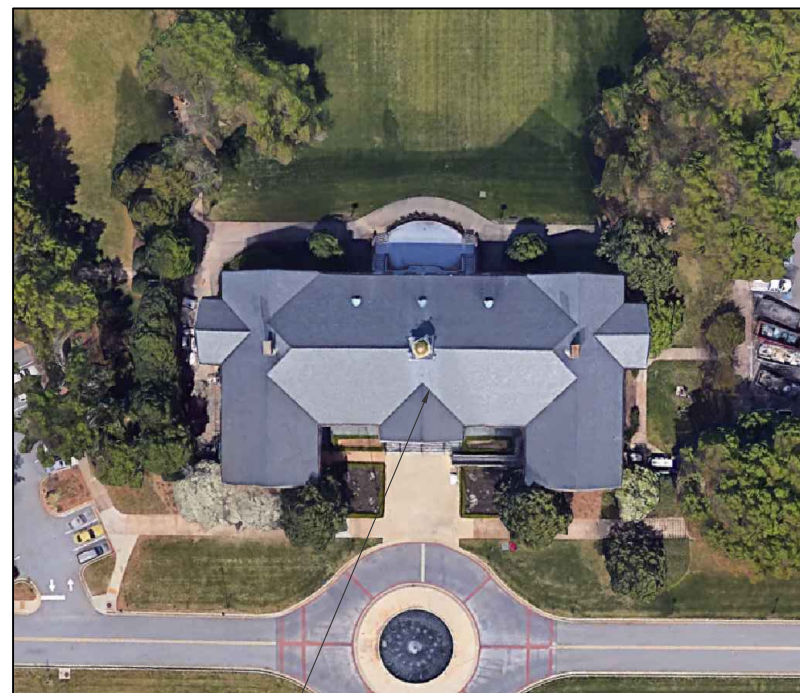

USC UPSTATE  
ADMINISTRATION BUILDING  
800 UNIVERSITY WAY  
SPARTANBURG, SC 29303  
**FACILITY MAP**

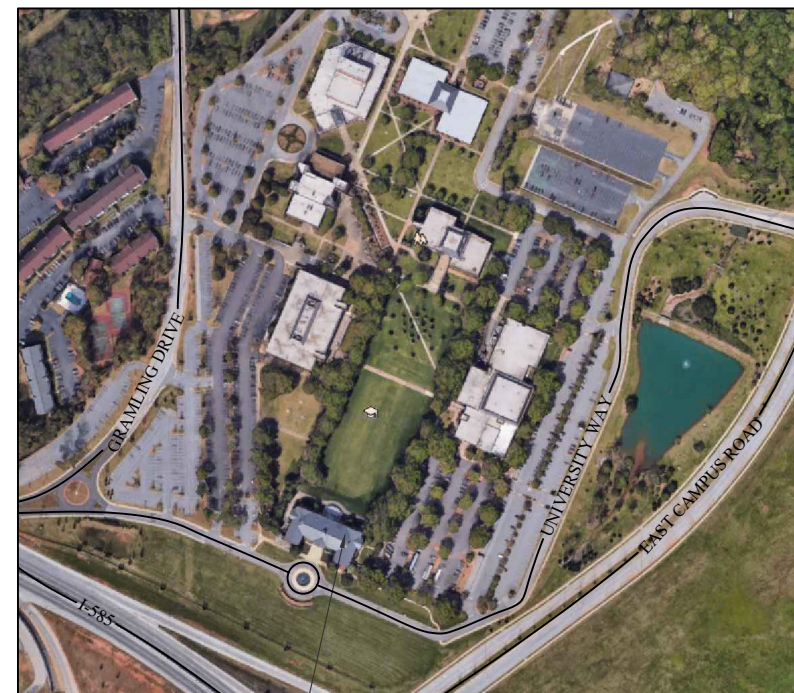

USC UPSTATE  
ADMINISTRATION BUILDING  
800 UNIVERSITY WAY  
SPARTANBURG, SC 29303  
**LOCATION MAP**

### EXISTING ROOF CORE SUMMARY

- ▲ XRX CORE NUMBER AND IDENTIFIER
- ▲ XFX FLASHING NUMBER AND IDENTIFIER



**BUILDING ENVELOPE CONSULTANTS, LLC**  
COLUMBIA AREA OFFICE

1501 CHAPIN ROAD  
CHAPIN, SOUTH CAROLINA  
EMAIL: CHRIS@WMBECONSULTANTS.COM  
EMAIL: DANIEL@WMBECONSULTANTS.COM

### CHARLESTON AREA OFFICE

1704 REDWOOD DRIVE  
MONCK'S CORNER, SOUTH CAROLINA  
EMAIL: JOE@WMBECONSULTANTS.COM

**NORTH**



PROJECT NUMBER: 2019-131

CONSTRUCTION DOCUMENTS

DATE: 2-3-2020

COVER PAGE

**PAGE:**

**R-1.0**

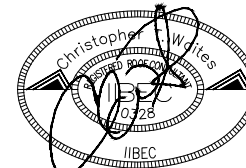

DESIGNED: CW

**UPSTATE - ADMINISTRATION BUILDING  
GUTTER REPLACEMENT AND ROOF REPAIR  
PROJECT NUMBER H34-954650002916-14**

**800 UNIVERSITY WAY  
SPARTANBURG, SC 29303**



**BUILDING ENVELOPE  
CONSULTANTS, LLC**

COLUMBIA AREA OFFICE

1501 CHAPIN ROAD  
CHAPIN, SOUTH CAROLINA  
EMAIL: CHRIS@WMBECONSULTANTS.COM  
EMAIL: DANIEL@WMBECONSULTANTS.COM

CHARLESTON AREA OFFICE

1704 REDWOOD DRIVE  
MONCK'S CORNER, SOUTH CAROLINA  
EMAIL: JOE@WMBECONSULTANTS.COM

**NORTH**

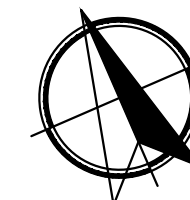

PROJECT NUMBER: 2019-131

CONSTRUCTION DOCUMENTS

DATE: 2-3-2020

EXISTING ROOF PLAN

**PAGE:**

**R-1.1**

SHEET 2 OF 4

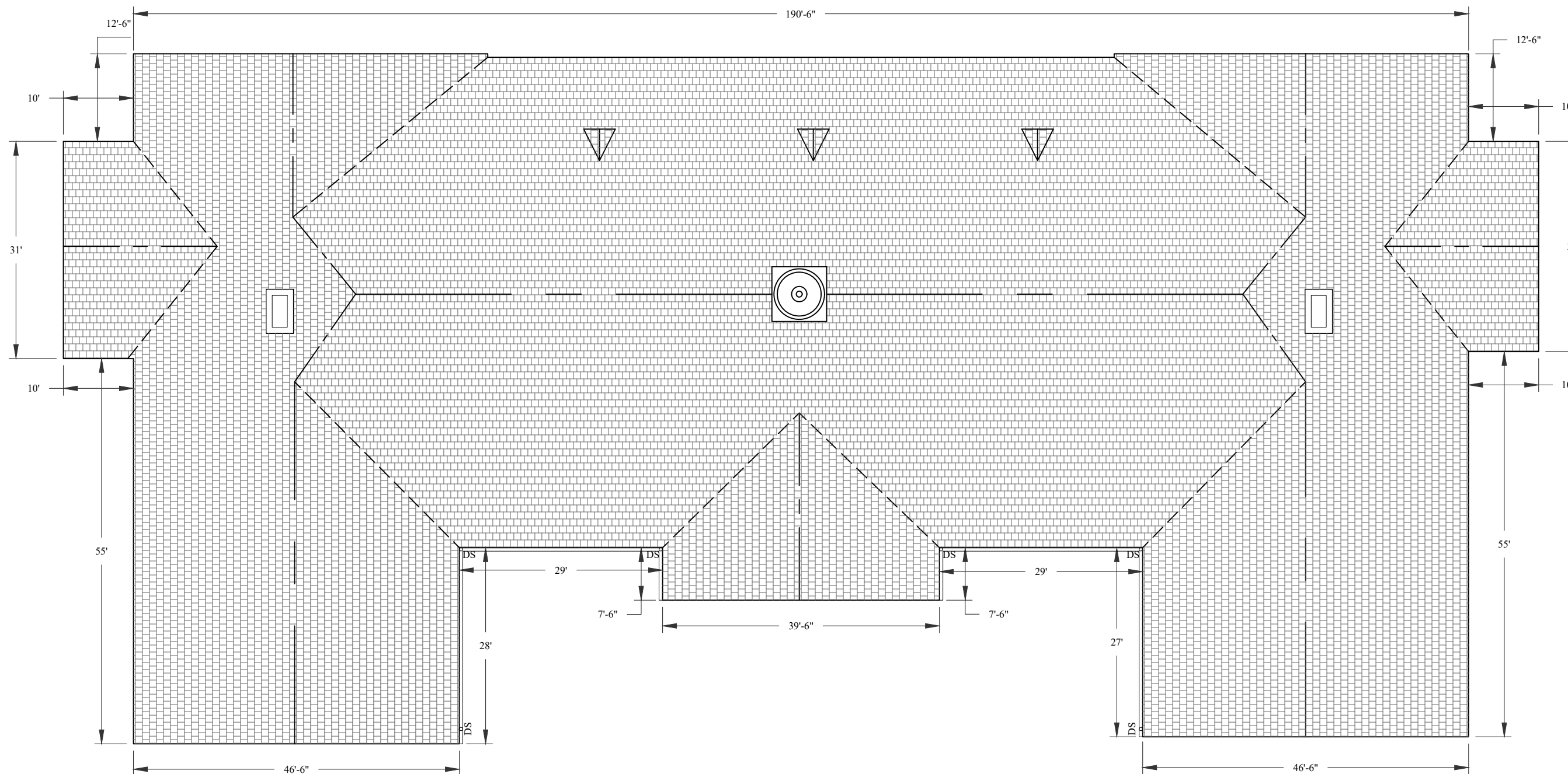

**EXISTING  
ROOF PLAN**



**GRAPHIC SCALE**

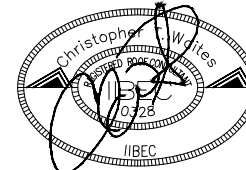

DESIGNED: CW

**UPSTATE - ADMINISTRATION BUILDING  
GUTTER REPLACEMENT AND ROOF REPAIR  
PROJECT NUMBER H34-954650002916-14**

**800 UNIVERSITY WAY  
SPARTANBURG, SC 29303**



**BUILDING ENVELOPE  
CONSULTANTS, LLC**

COLUMBIA AREA OFFICE

1501 CHAPIN ROAD  
CHAPIN, SOUTH CAROLINA  
EMAIL: CHRIS@WMBECONSULTANTS.COM  
EMAIL: DANIEL@WMBECONSULTANTS.COM

CHARLESTON AREA OFFICE

1704 REDWOOD DRIVE  
MONCK'S CORNER, SOUTH CAROLINA  
EMAIL: JOE@WMBECONSULTANTS.COM

**NORTH**

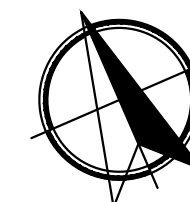

PROJECT NUMBER: 2019-131

CONSTRUCTION DOCUMENTS

DATE: 2-3-2020

ROOF REPAIR PLAN

**PAGE:**

**R-1.2**

SHEET 3 OF 4

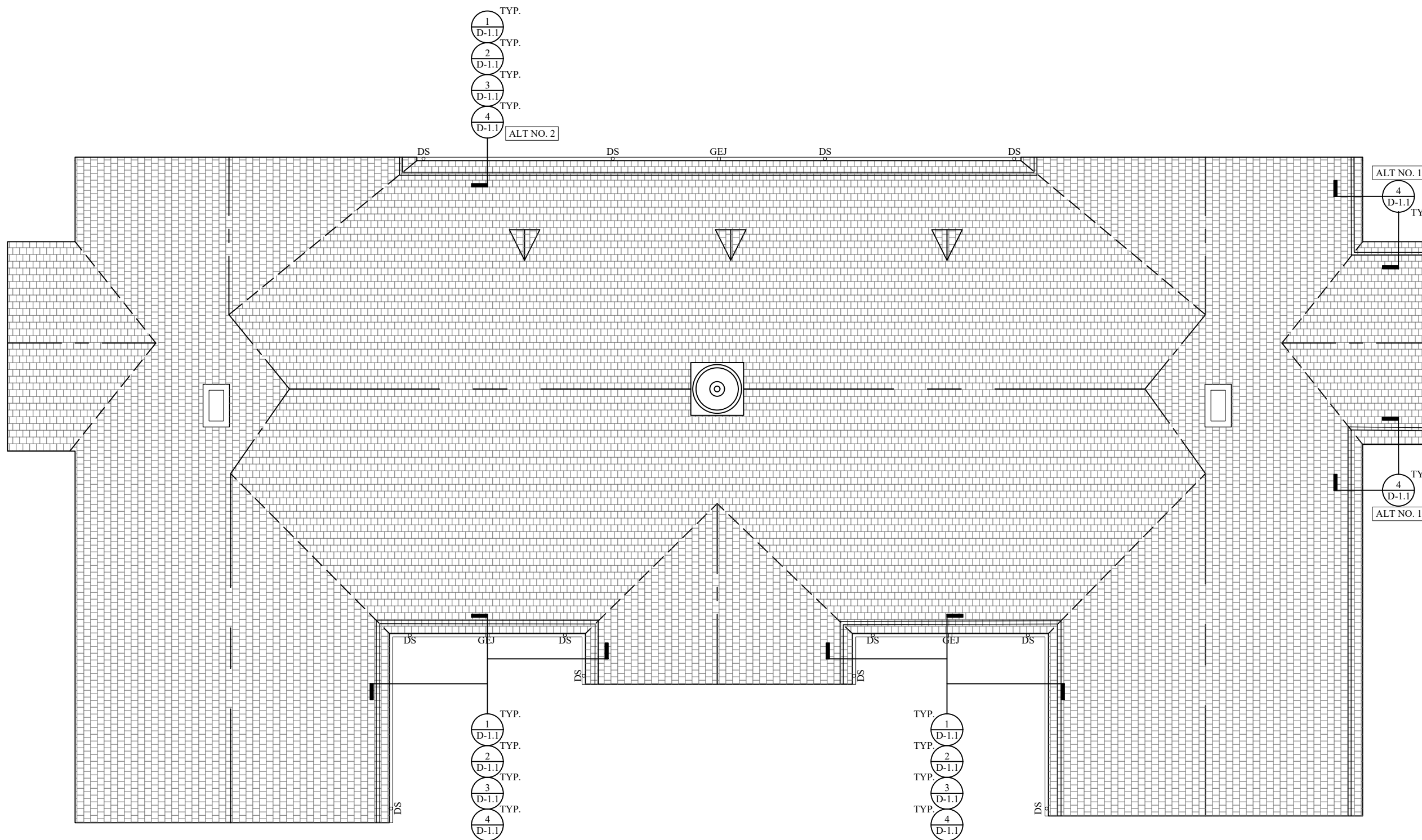

**ROOF REPAIR  
PLAN**



**GRAPHIC SCALE**



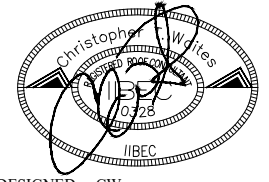

DESIGNED: CW

**UPSTATE - ADMINISTRATION BUILDING  
GUTTER REPLACEMENT AND ROOF REPAIR  
PROJECT NUMBER H34-954650002916-14**

**800 UNIVERSITY WAY  
SPARTANBURG, SC 29303**



**BUILDING ENVELOPE  
CONSULTANTS, LLC  
COLUMBIA AREA OFFICE**

1501 CHAPIN ROAD  
CHAPIN, SOUTH CAROLINA  
EMAIL: CHRIS@WMBECONSULTANTS.COM  
EMAIL: DANIEL@WMBECONSULTANTS.COM

**CHARLESTON AREA OFFICE**

1704 REDWOOD DRIVE  
MONCK'S CORNER, SOUTH CAROLINA  
EMAIL: JOE@WMBECONSULTANTS.COM

PROJECT NUMBER: 2019-131

CONSTRUCTION DOCUMENTS

DATE: 2-3-2020

DETAILS

**PAGE:**

**D-1.1**

SHEET 4 OF 4

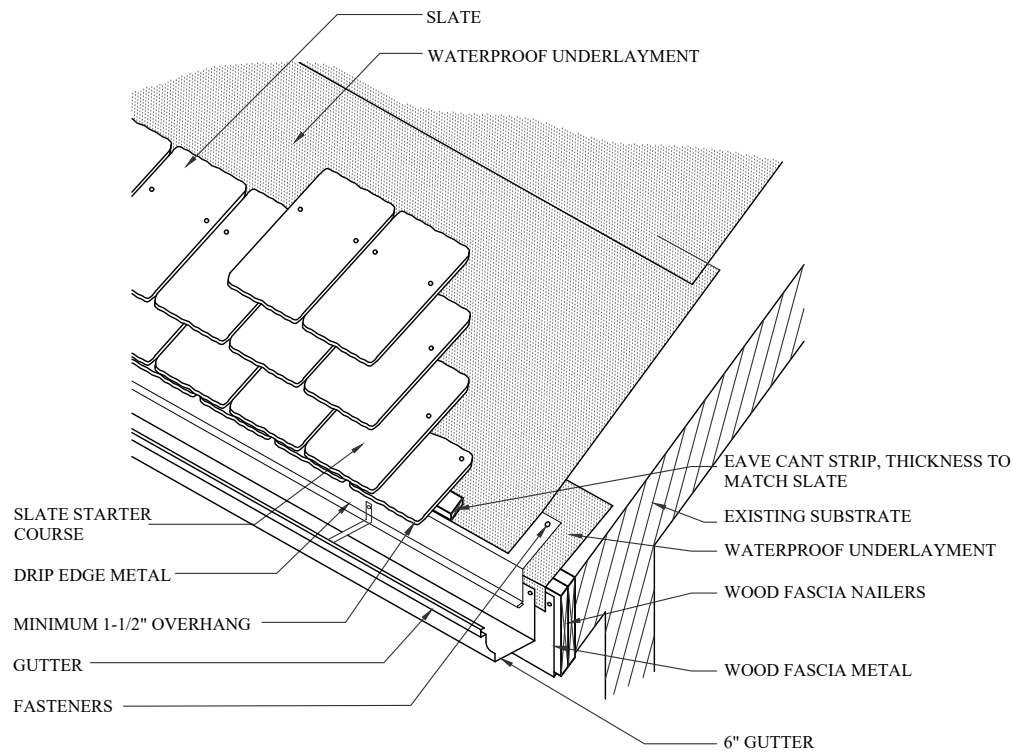

**ROOF EDGE WITH GUTTER**

**DETAIL 1/D1.1**

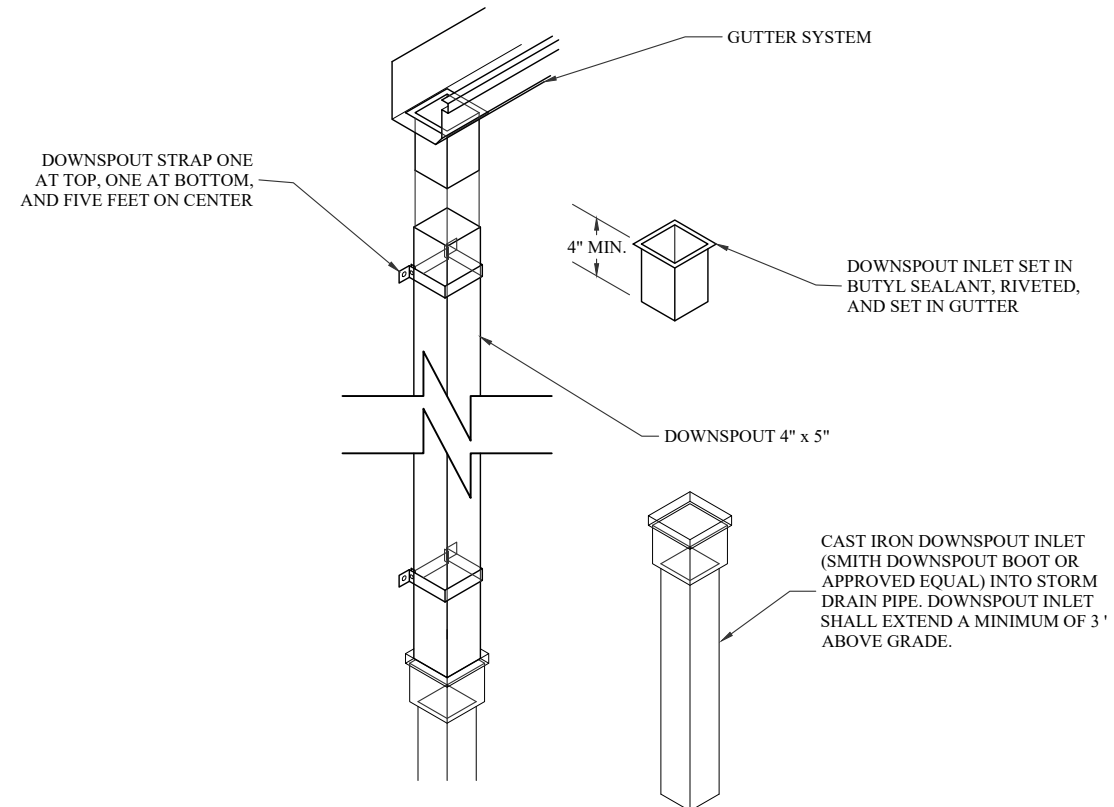

**DOWNSPOUT**

**DETAIL 2/D1.1**

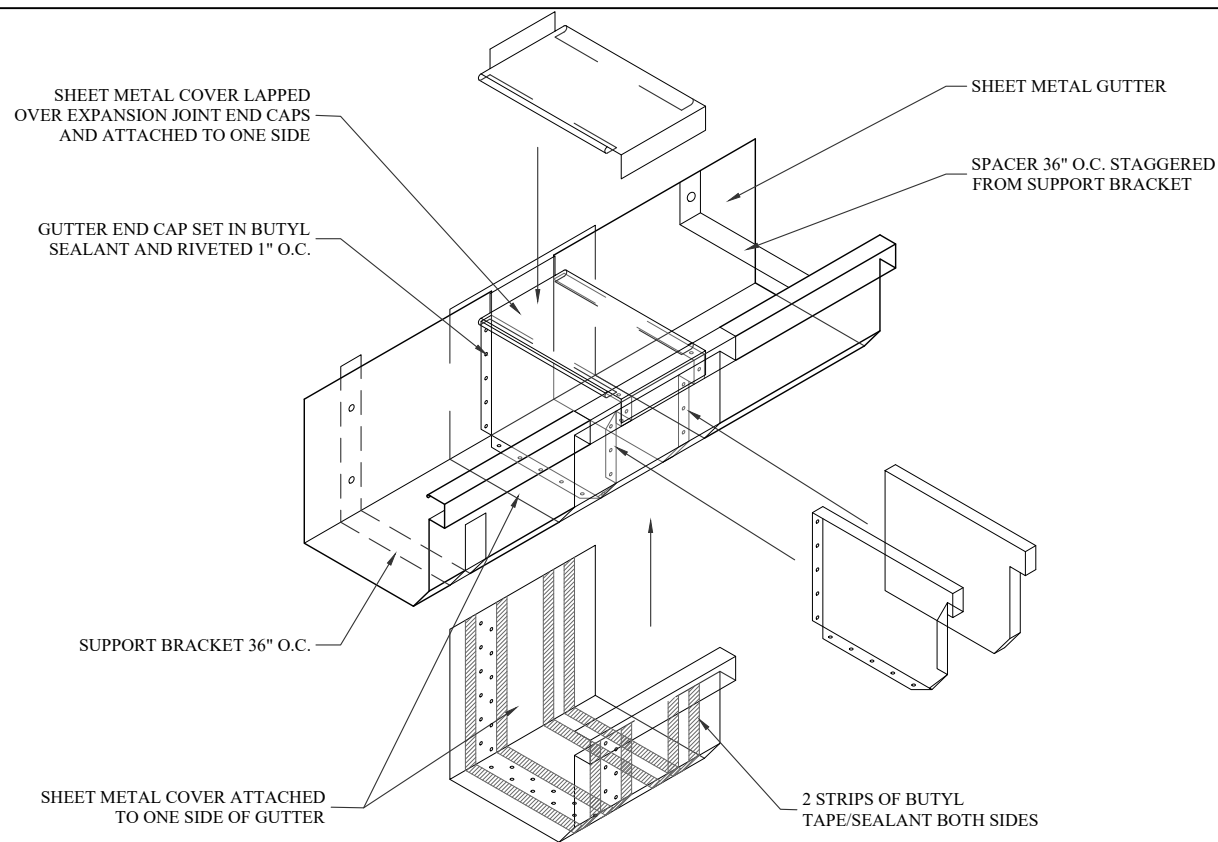

**GUTTER EXPANSION JOINT**

**DETAIL 3/D1.1**

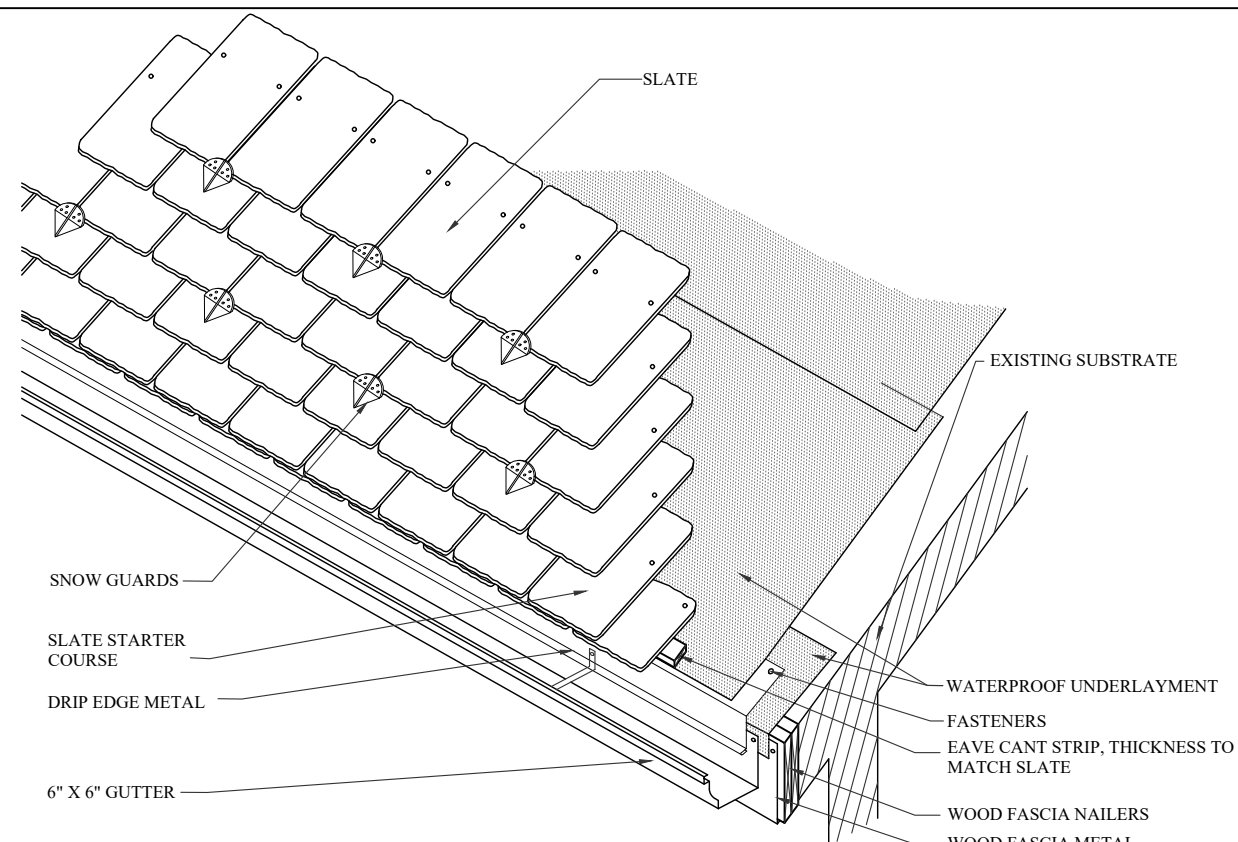

**SNOW GUARD PATTERN**

**DETAIL 4/D1.1**